



Datasheet

IQsafeLink v3 Advanced



Versie:

1 augustus 2016

IQsafeLink

Een product van Armac B.V.

Adres
Buskesdries 2
6673 DP

E-mail info@armac.nl
Tel. +31 (0) 488 451 236
Fax +31 (0) 488 452 367
Web www.armac.nl
www.iqsafelink.com

BTW NL8072.35.465.B.01
Bank NL11RABO0133944441
BIC RABONL2UAndelst
KvK 100.35.834

Inhoudsopgave

1	Hardware specificaties	4
2	Afmetingen	5
3	Aansluiten	8
3.1	Voeding	8
3.2	Serieel	8
3.3	Algemeen	9

1 Hardware specificaties

BEHUIZING	
AFMETINGEN	180 x 134 x 50 mm (WxDxH)
GEWICHT	± 1 Kg
CPU	Intel BayTrail Quad Core J1900
WERKGEHEUGEN	4Gb RAM
OPSLAGCAPACITEIT	64Gb SSD
VOEDING	
INKOMENDE SPANNING	16-30 VDC
EMC RICHTLIJN	
EMC	EN55022 class B
INTERFACES	
USB2.0	4x
USB3.0	1x
WAN	1x
HDMI	1x
VGA	1x
COM	2x
OPERATING SYSTEM	
CORE	Linux
VIRTUELE MACHINE	Microsoft Windows 7 64bit
OMGEVING	
KOELING	Passief
TEMPERATUUR	0 – 50 °C
VOCHTIGHEID	10% - 90% @ 39 °C, zonder condens

2 Afmetingen

De afmetingen van de IQsafelink box zijn:

Hoogte 55 mm

Diepte 116 mm

Breedte 178 mm

De box beschikt over twee COM-poorten (BIOS instelbaar), twee ethernetpoorten, één HDMI-poort, één VGA poort, twee ethernet-poorten en vier USB2.0-poorten en één USB3.0-poort. De box zal uitgevoerd worden in zwart aluminium.

De HDMI- en VGA-poort zijn alléén voor service doeleinde. Dus niet te gebruiken voor de eindgebruiker.

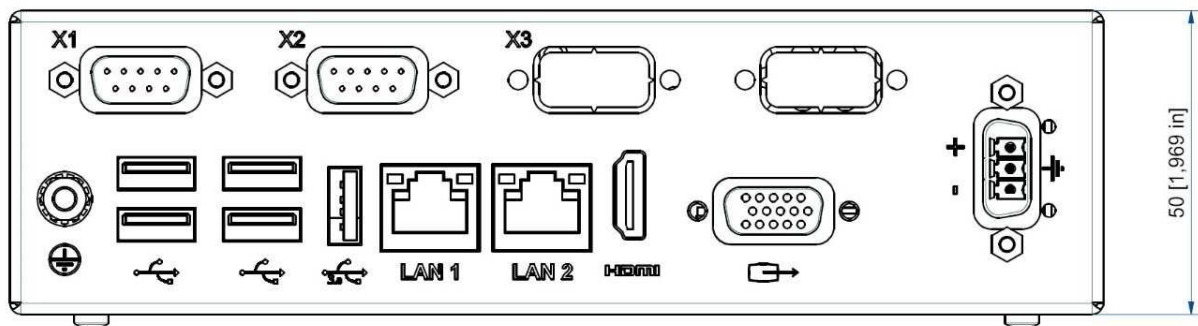

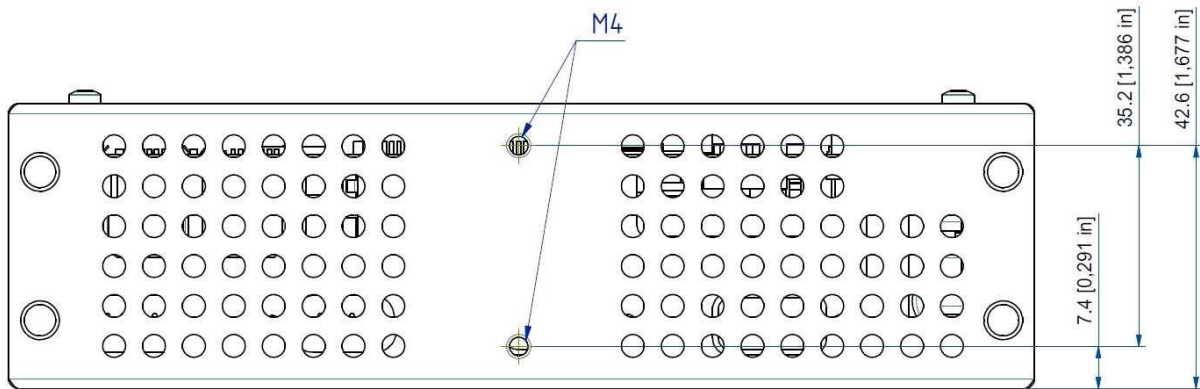
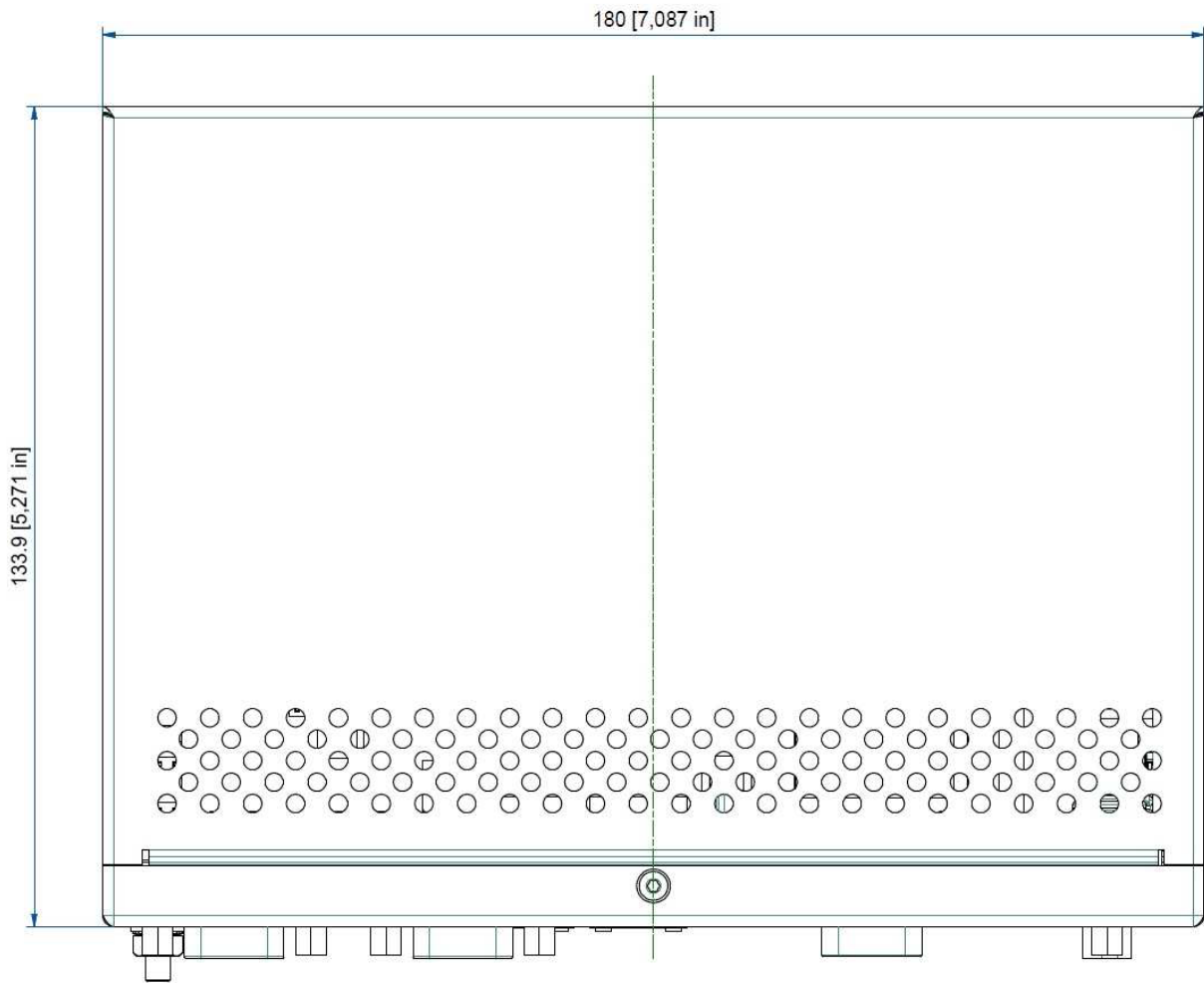

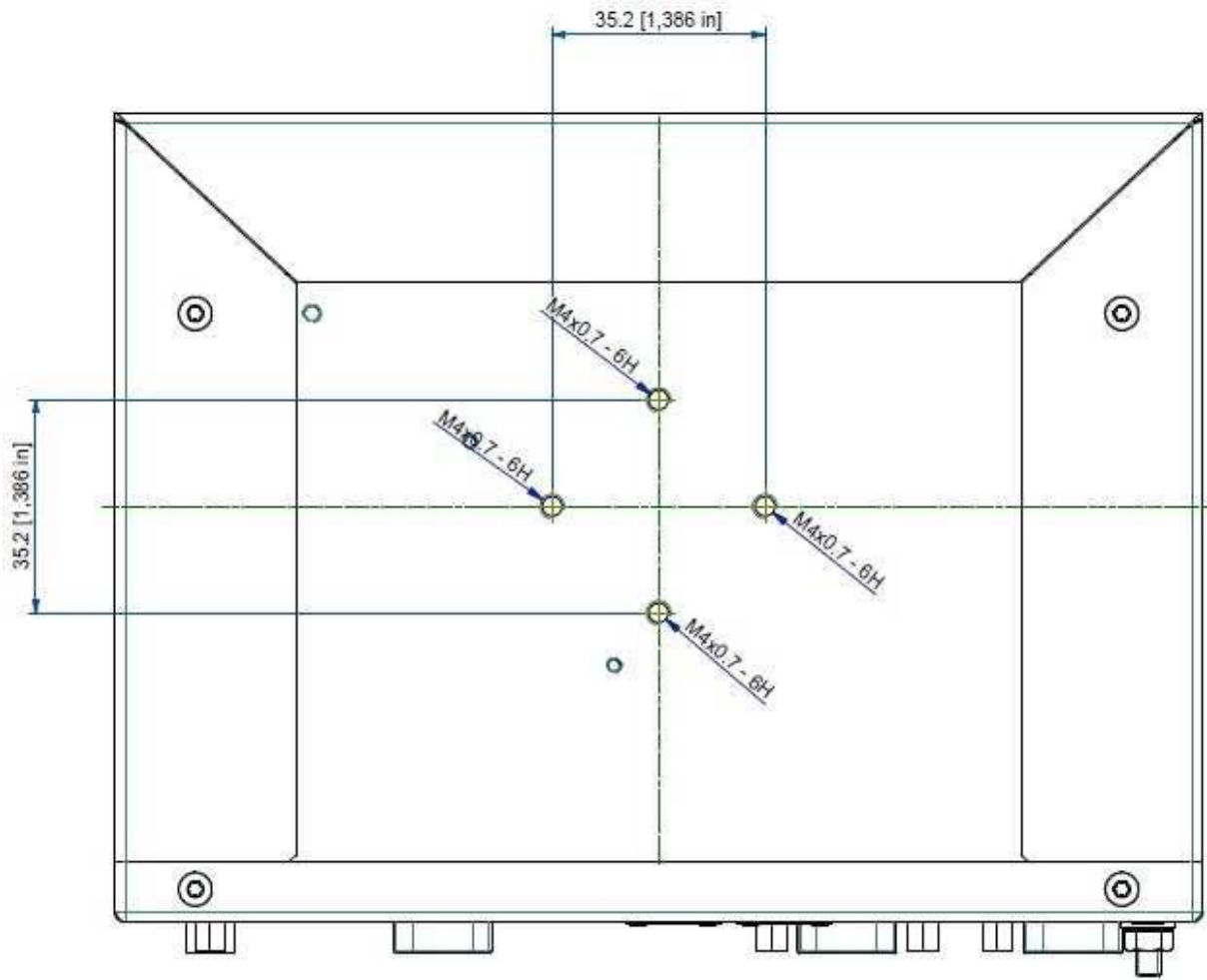

Max. M4x6

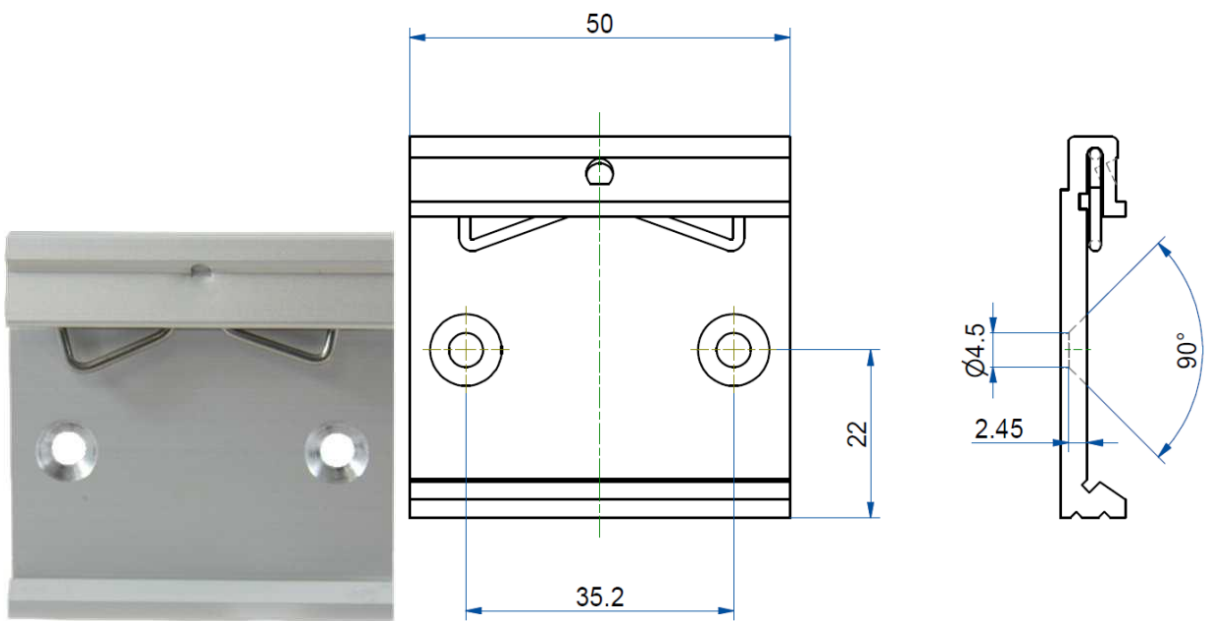

Max. M4x8



3 Aansluiten

3.1 Voeding

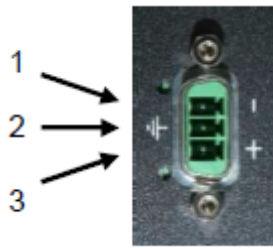

Pin	Signal
1	GND
2	Shield
3	VCC

3.2 Serieel

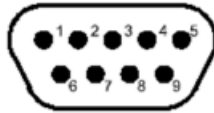

Pin	RS-232	RS-422	Half Duplex RS-485	Full Duplex RS-485
1	DCD	Tx-	DATA-	Tx-
2	RxD	Tx+	DATA+	Tx-
3	TxD	Rx+	-	Rx+
4	DTR	Rx-	-	Rx-
5	GND	GND	GND	GND
6	DSR	-	-	-
7	RTS	-	-	-
8	CTS	-	-	-
9	RI	-	-	-

3.3 Algemeen

